

- T&G / SIDING -

3.1875

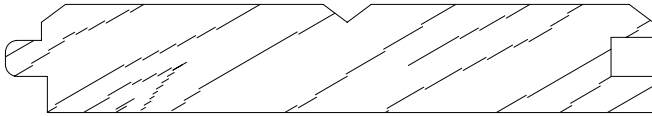

SCM 9001
9/16 X 3-3/8

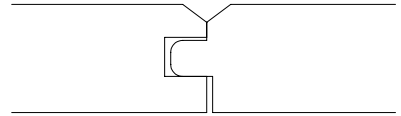

SCM 9001

3.1875

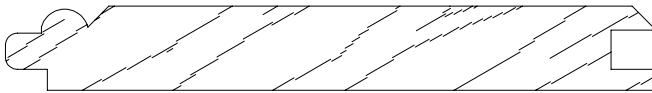

SCM 9002
7/16 X 3-3/8

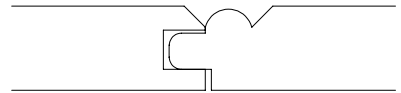

SCM 9002

2.1875

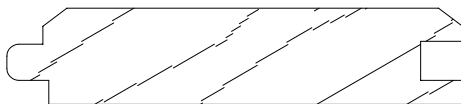

SCM 9003
1/2 X 2-3/8

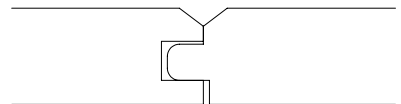

SCM 9003

2.3125

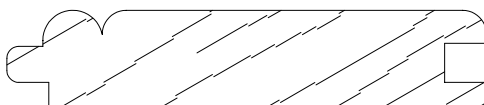

SCM 9004
1/2 X 2-1/2

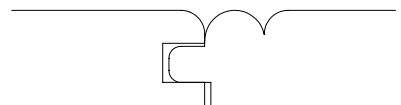

SCM 9004

- T&G / SIDING -

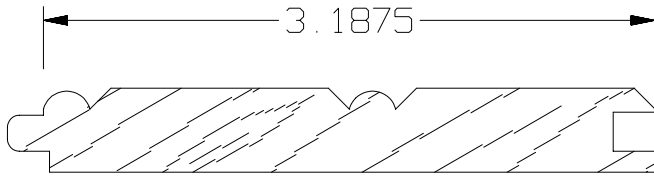

SCM 9005
7/16 X 3-3/8

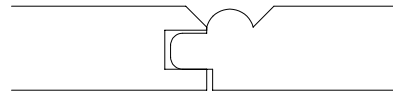

SCM 9005

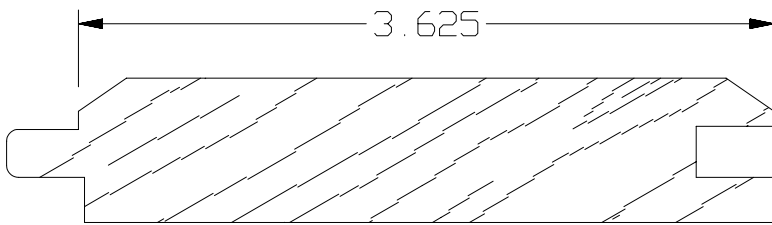

SCM 9006
3/4 X 4

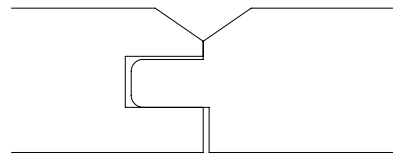

SCM 9006

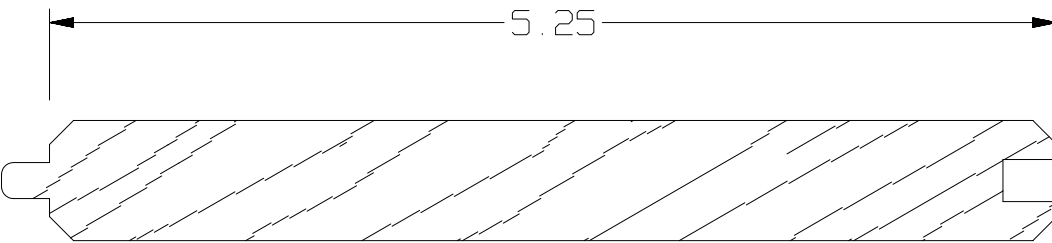

SCM 9007
5/8 X 5-1/2

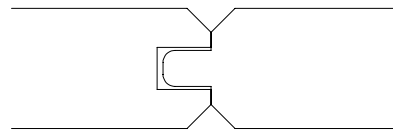

SCM 9007



SCM 9008
9/16 X 3

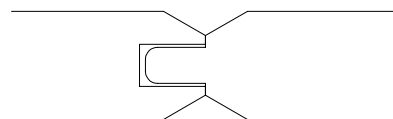

SCM 9008

- T&G / SIDING -

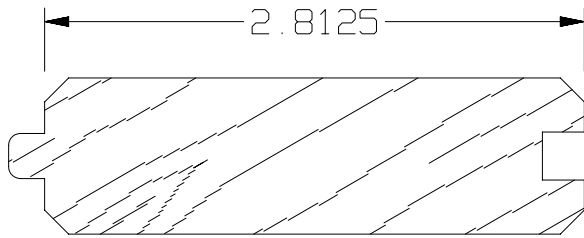

SCM 9009
13/16 X 3

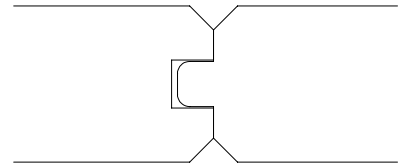

SCM 9009

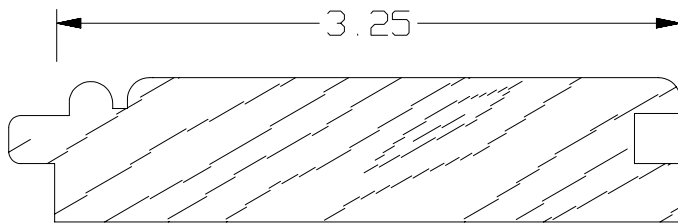

SCM 9010
3/4 X 3-1/2

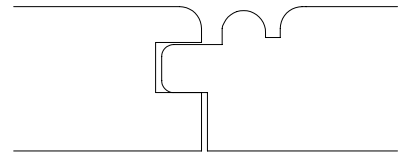

SCM 9010

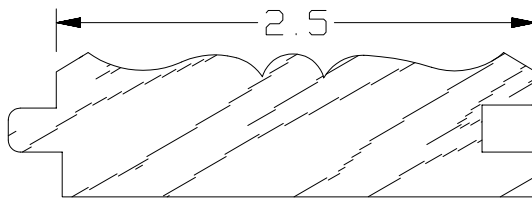

SCM 9011
3/4 X 2-3/4

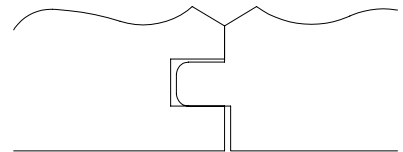

SCM 9011

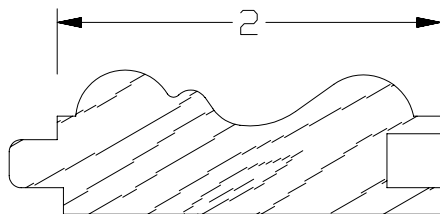

SCM 9012
3/4 X 2-1/4

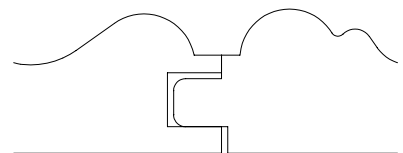

SCM 9012

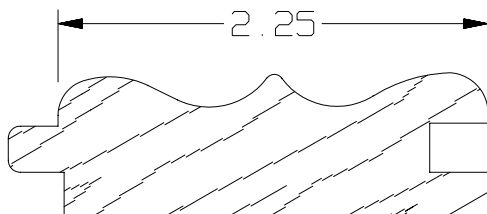

SCM 9013
3/4 X 2-1/2

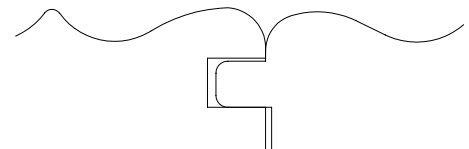

SCM 9013

- T&G / SIDING -

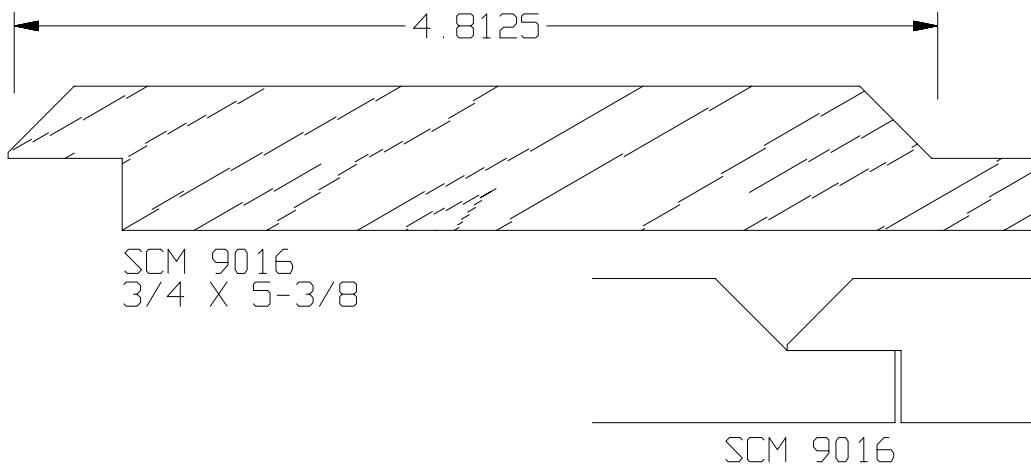
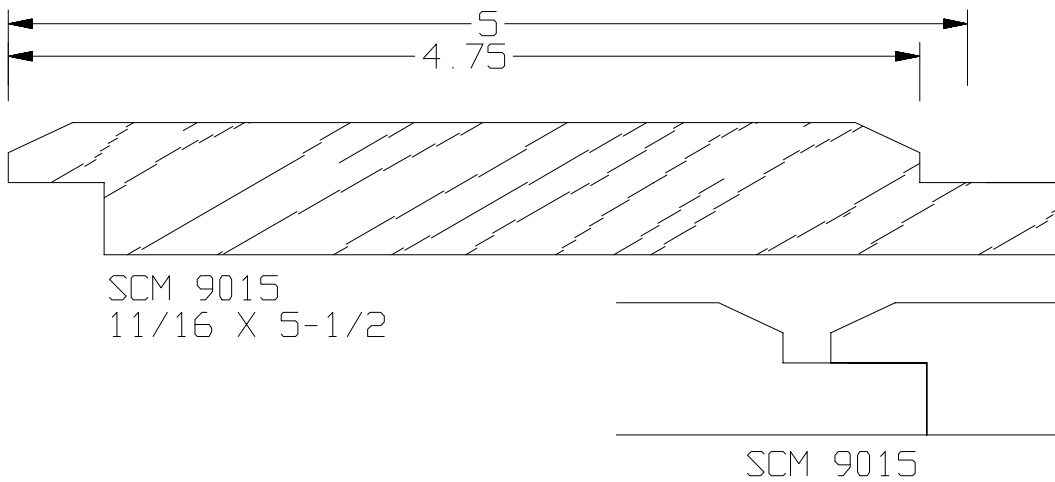
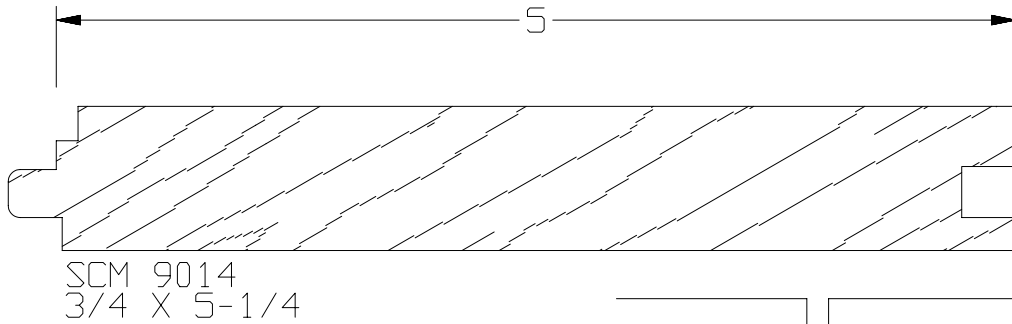

- T&G / SIDING -

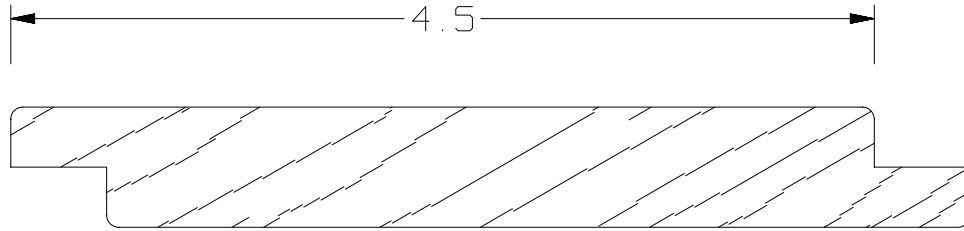

SCM 9017
5/8 X 5

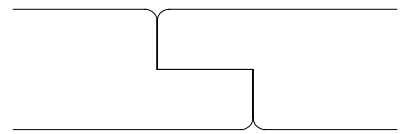

SCM 9017

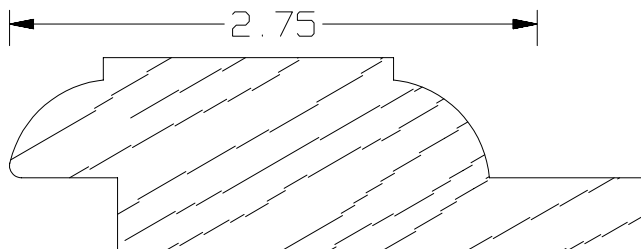

SCM 9018
1 X 3-5/16

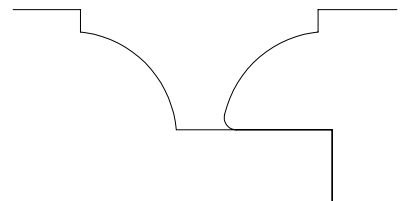

SCM 9018

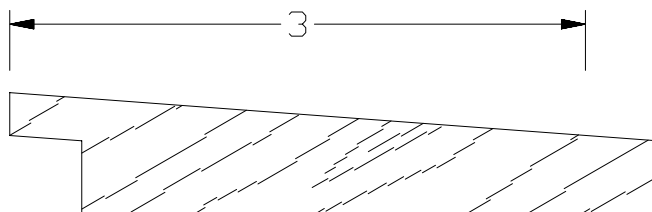

SCM 9019
5/8 X 3-3/8

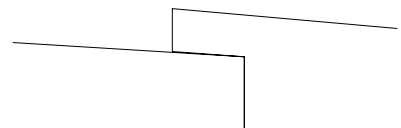

SCM 9019

- T&G / SIDING -

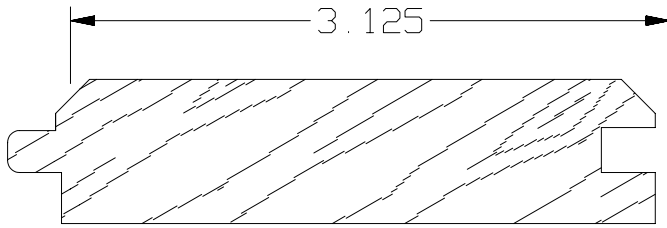

SCM 9020
3/4 X 3-3/8

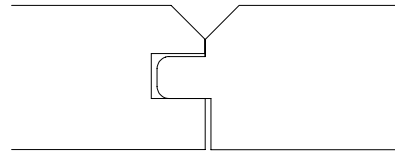

SCM 9020

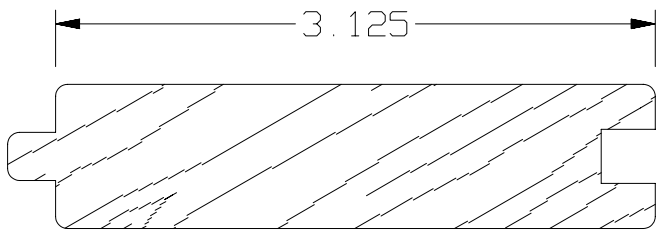

SCM 9021
11/16 X 3-3/8

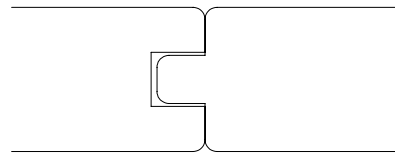

SCM 9021

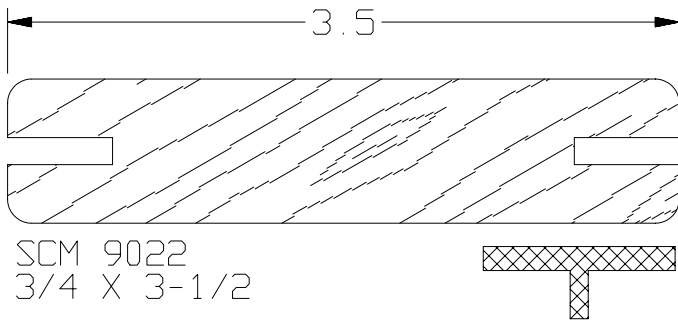

SCM 9022
3/4 X 3-1/2

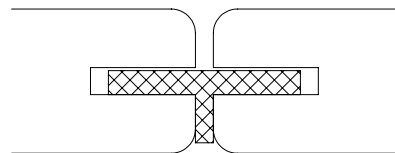

SCM 9022

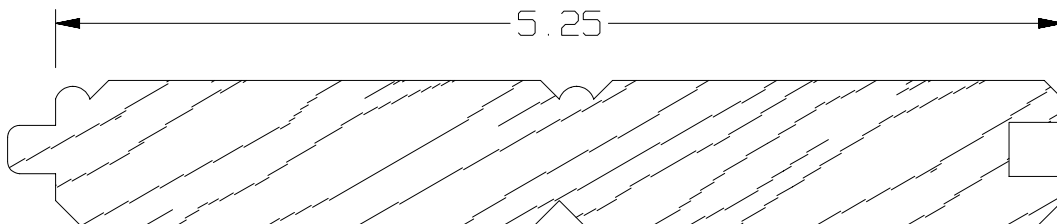

SCM 9023
3/4 X 5-1/2

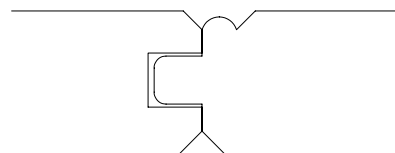

SCM 9023

- T&G / SIDING -

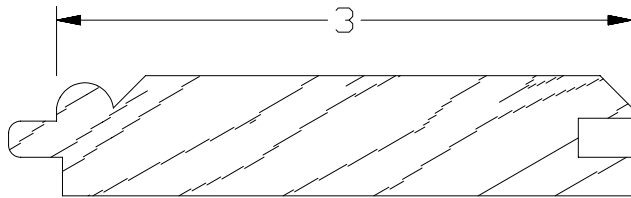

SCM 9024
5/8 X 3-1/4

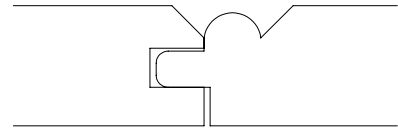

SCM 9024

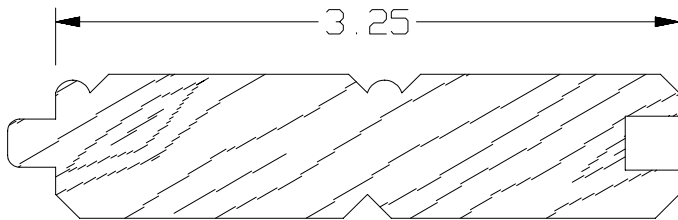

SCM 9025
3/4 X 3-1/2

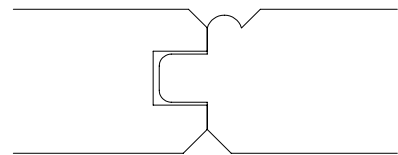

SCM 9025

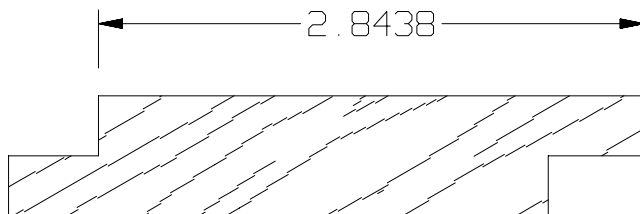

SCM 9026
5/8 X 3-5/16

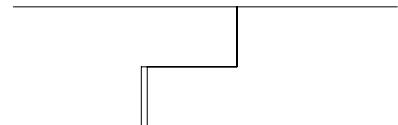

SCM 9026

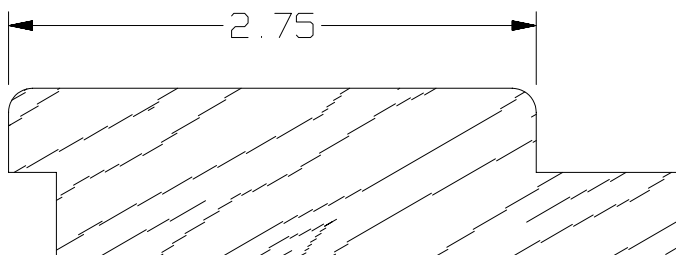

SCM 9027
7/8 X 3-1/2

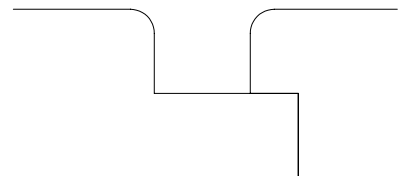

SCM 9027

- T&G / SIDING -

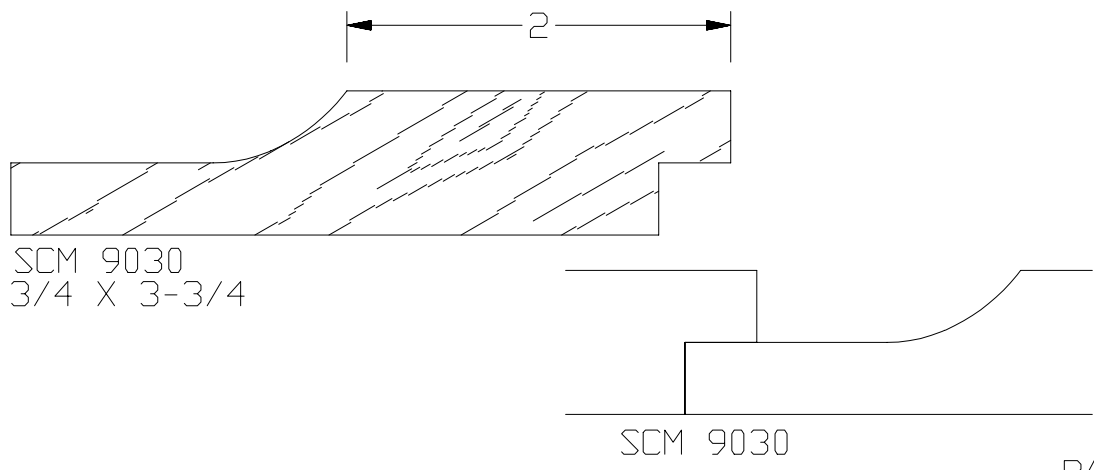
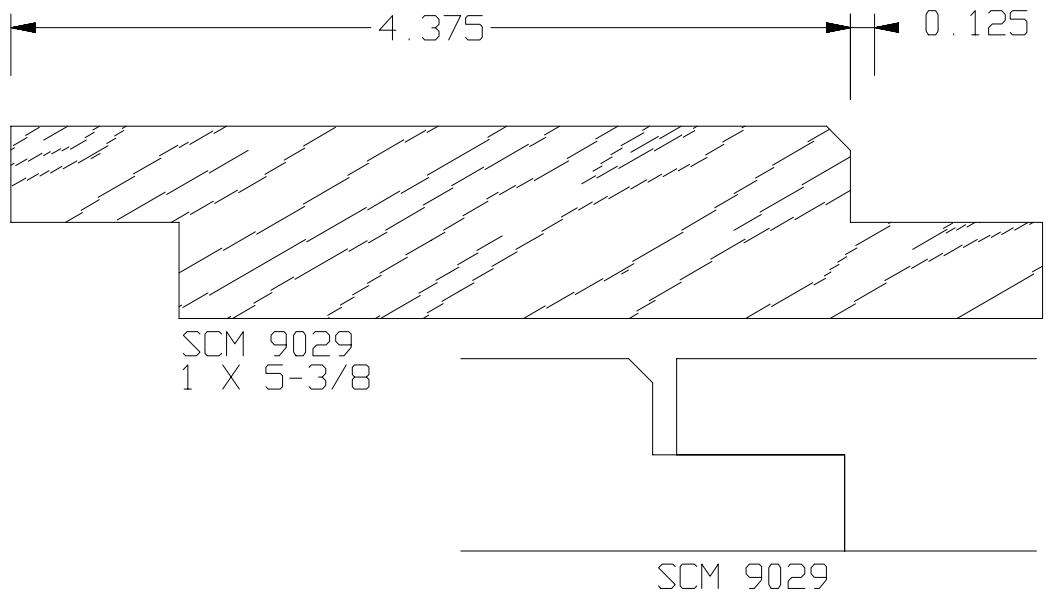
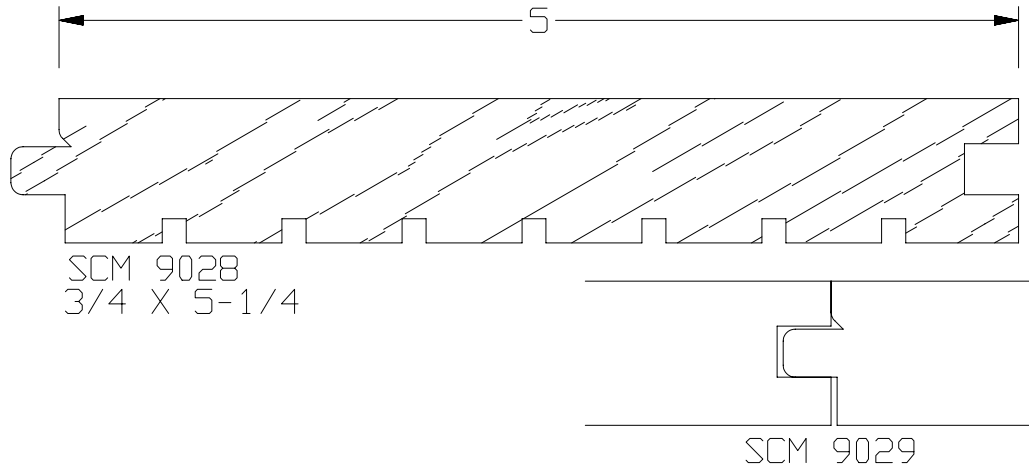

- T&G / SIDING -

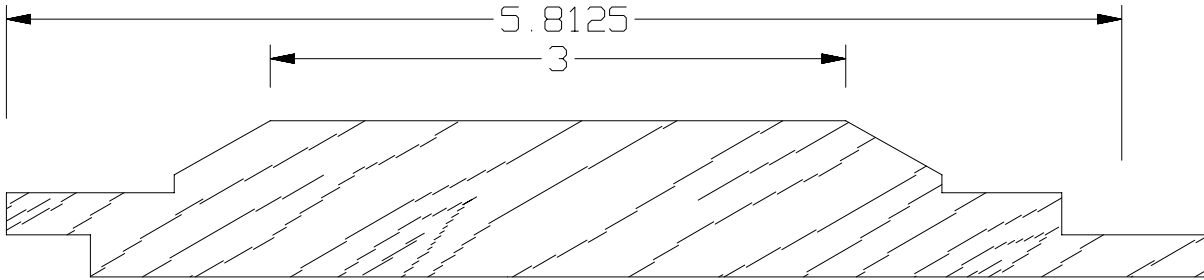

SCM 9031
13/16 X 6-1/4

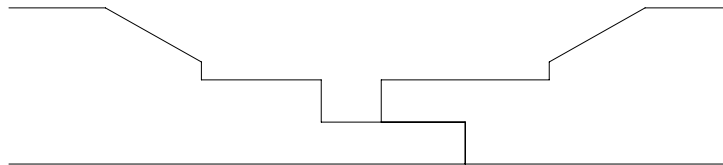

SCM 9031

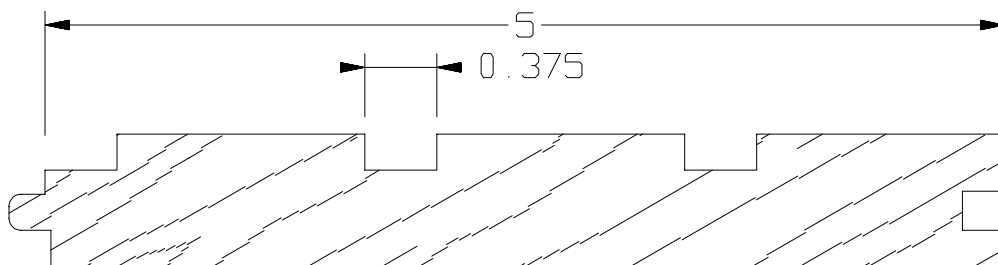

SCM 9032
11/16 X 5

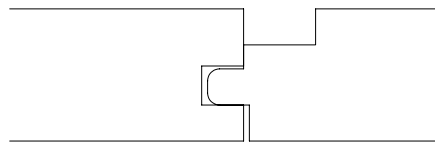

SCM 9032

- T&G / SIDING -

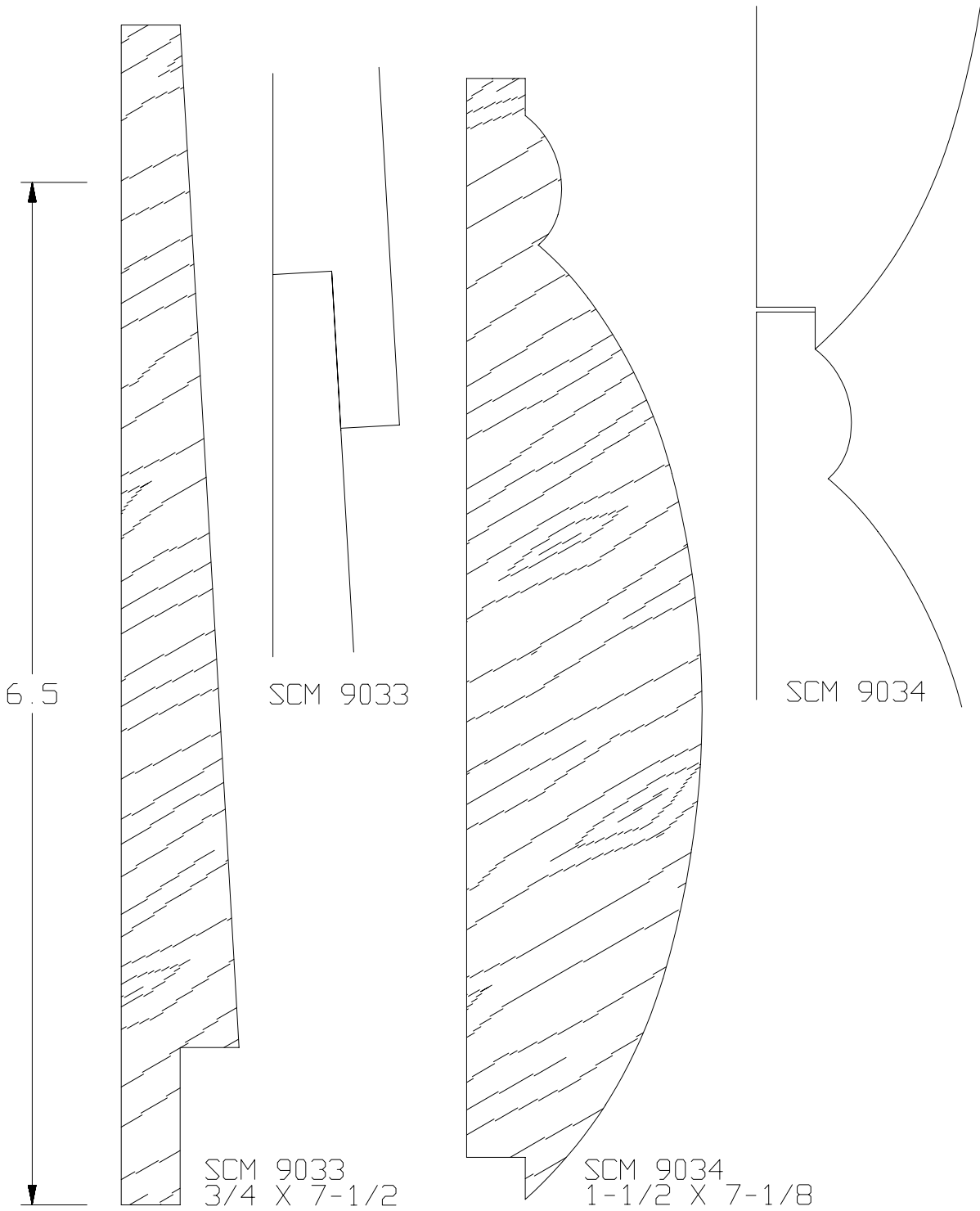

- T&G / SIDING -

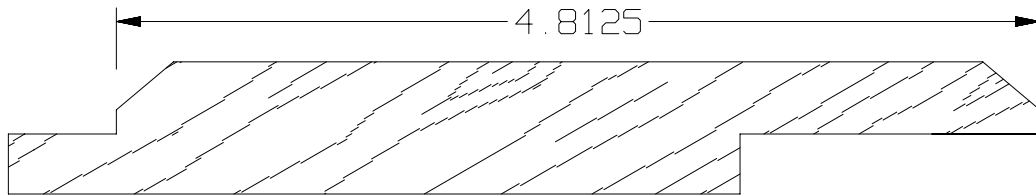

SCM 9035
11/16 X 5-3/8

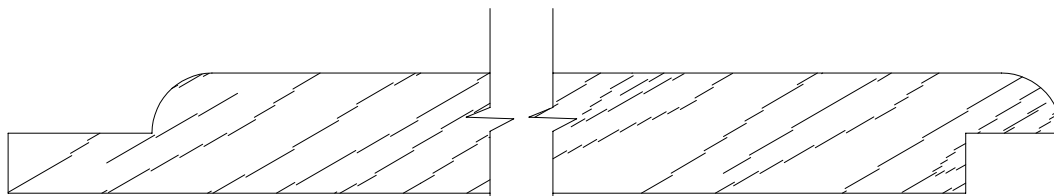
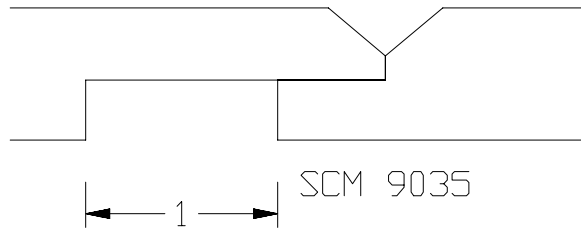

SCM 9036
5/8 X 9-3/8

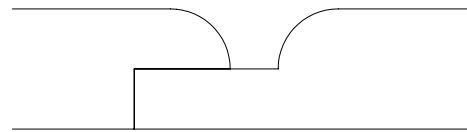

SCM 9036

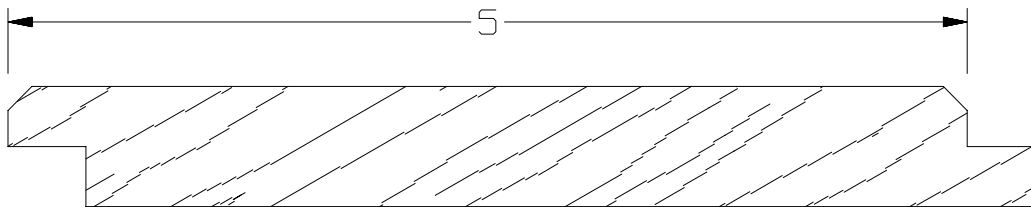

SCM 9037
5/8 X 5-3/8

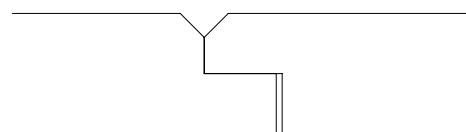

SCM 9037

- T&G / SIDING -

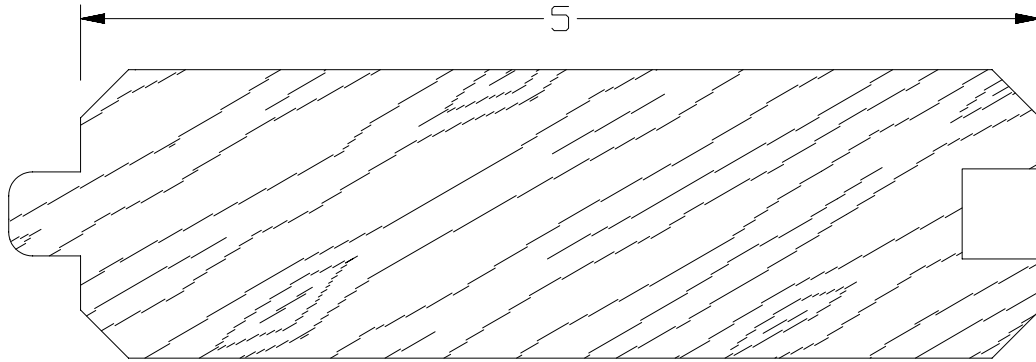

SCM 9038
1-1/2 X 5-3/8

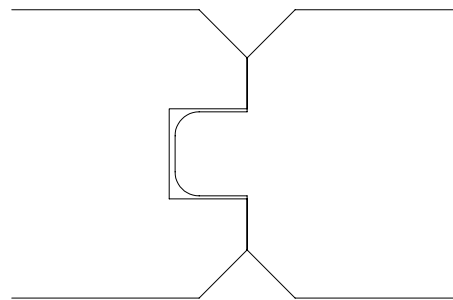

SCM 9038

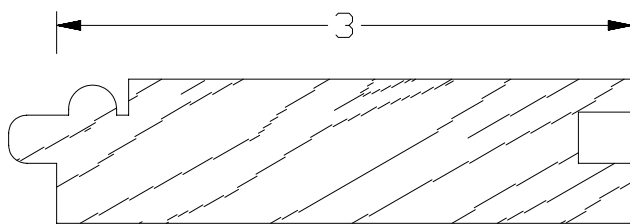

SCM 9039
3/4 X 3-1/4

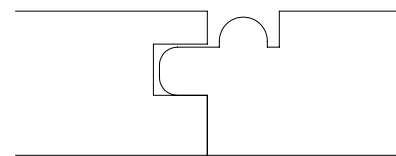

SCM 9039

SEATTLE CABINET & MILLWORK
16705 Tye St. SE Monroe WA 98272
Toll Free (866) 563-9129 Fax (360) 794-5331

- T&G / SIDING -

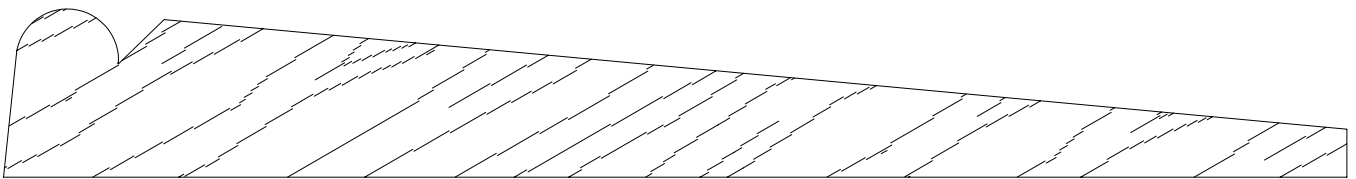

SCM 9040
7/8 X 7

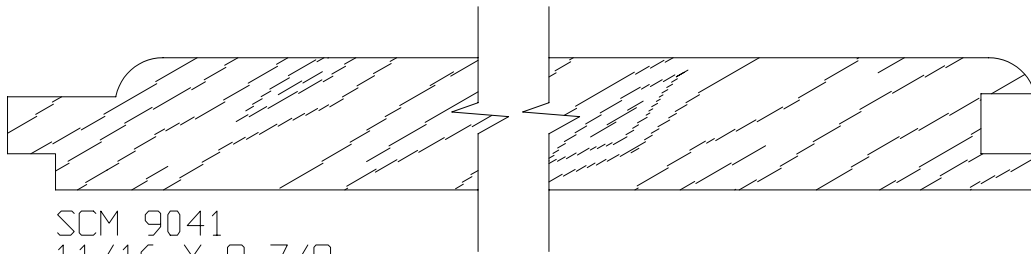

SCM 9041
11/16 X 8-7/8

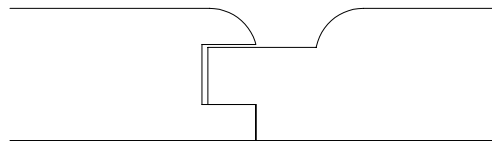

SCM 9041