

- HANDRAIL -

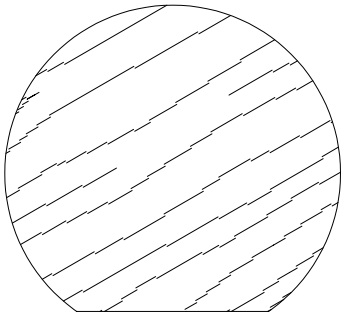

SCM 13001
1-5/8 X 1-3/4

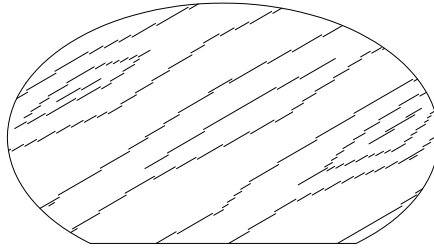

SCM 13002
1-1/4 X 2-1/4

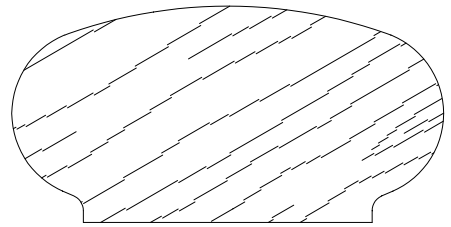

SCM 13003
1-1/8 X 2-1/4

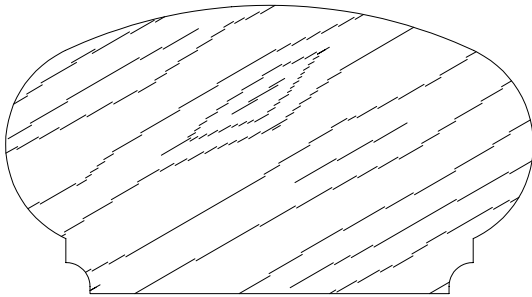

SCM 13004
1-1/2 X 2-3/4

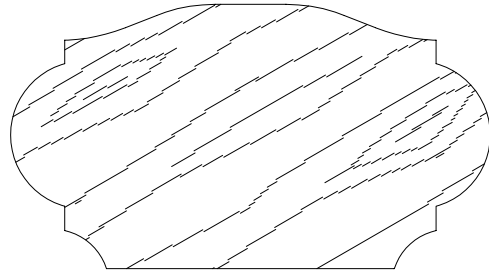

SCM 13005
1-3/8 X 2-1/2

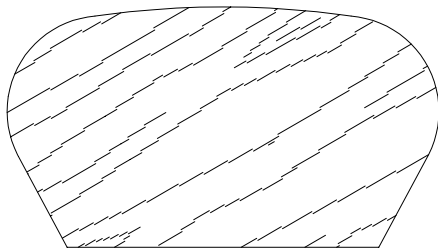

SCM 13006
1-1/4 X 2-1/4

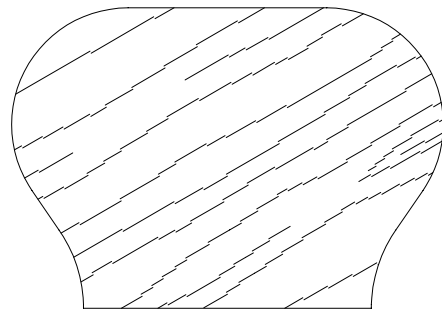

SCM 13007
1-9/16 X 2-1/4

- HANDRAIL -

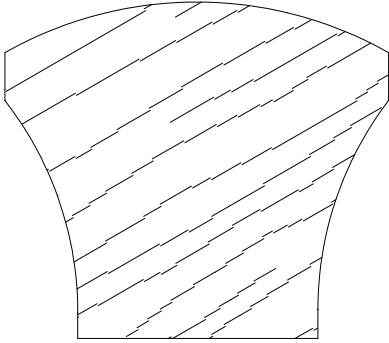

SCM 13008
1-3/4 X 2

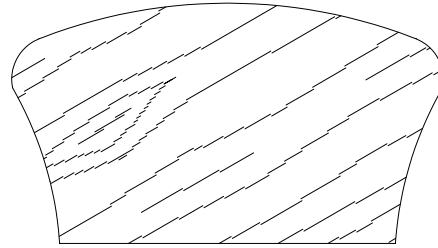

SCM 13009
1-1/4 X 2-1/4

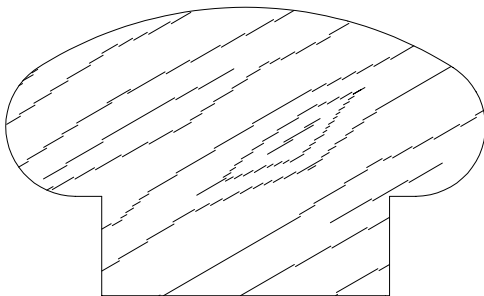

SCM 13010
1-1/2 X 2-1/2

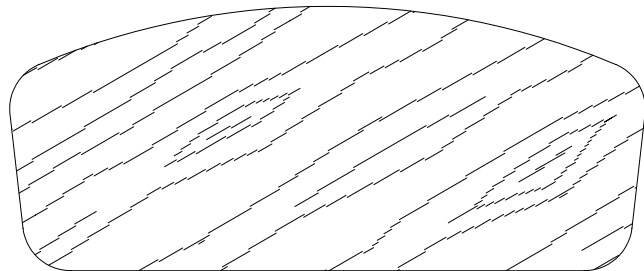

SCM 13011
1-3/8 X 3-5/16

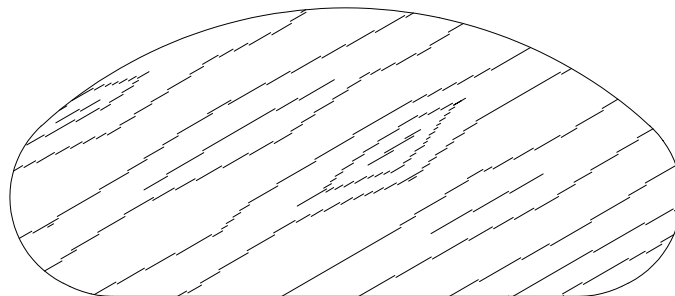

SCM 13012
1-1/2 X 3-1/2

- HANDRAIL -

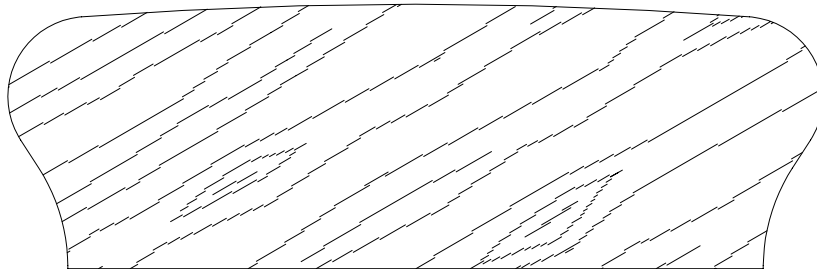

SCM 13013
1-3/8 X 4-1/4

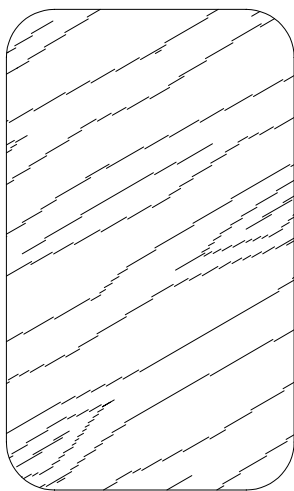

SCM 13014
1-1/2 X 2-1/2

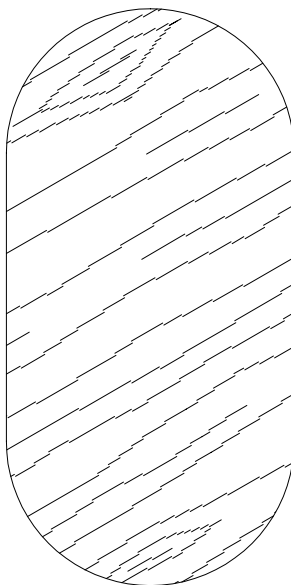

SCM 13015
1-1/2 X 3

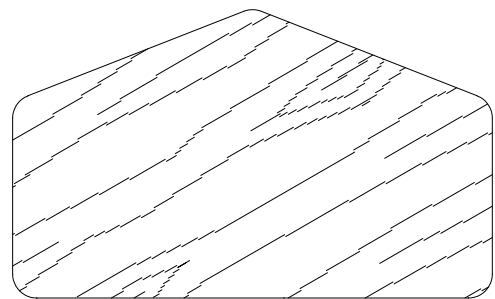

SCM 13016
1-1/2 X 2-1/2

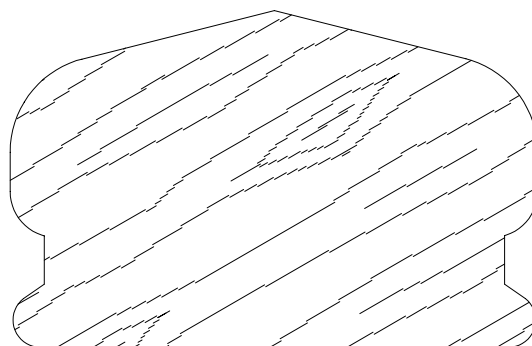

SCM 13017
1-3/4 X 2-3/4

- HANDRAIL -

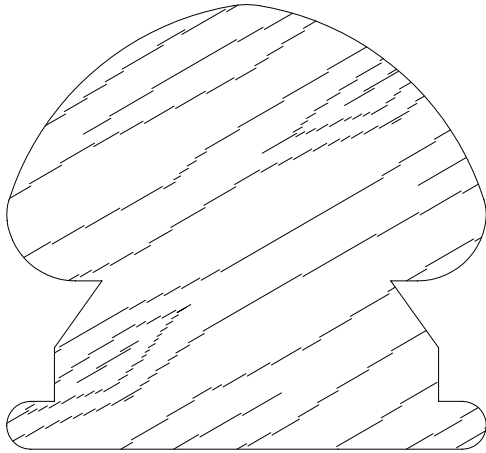

SCM 13018
2-5/16 X 2-1/2

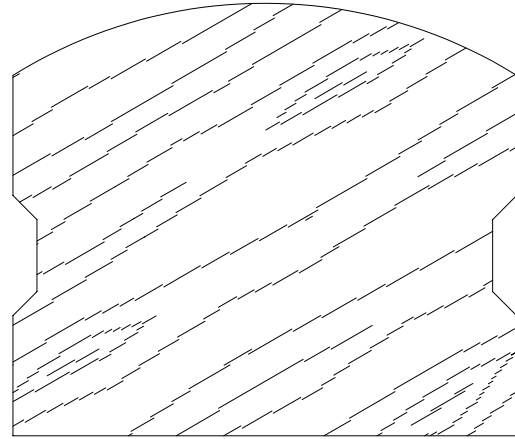

SCM 13019
2-1/4 X 2-5/8

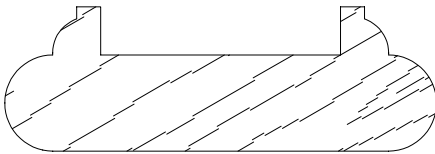

SCM 13001S
3/4 X 2-1/4

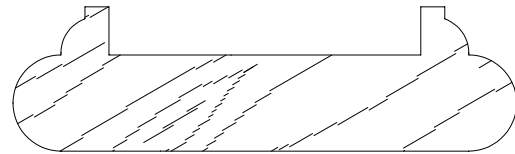

SCM 13002S
3/4 X 2-5/8

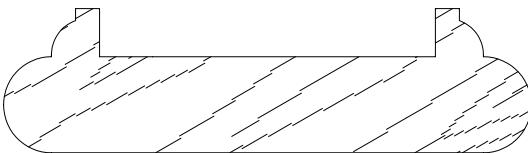

SCM 13003S
3/4 X 2-3/4

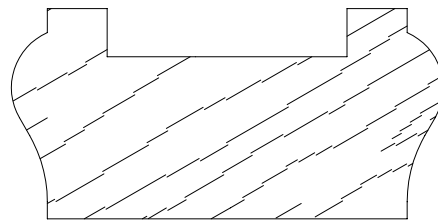

SCM 13004S
1-3/32 X 2-1/4

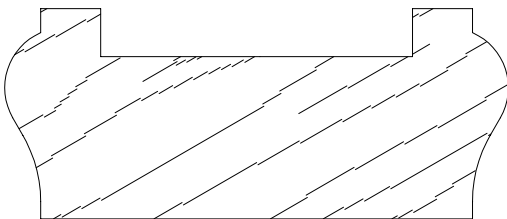

SCM 13005S
1-3/32 X 2-5/8

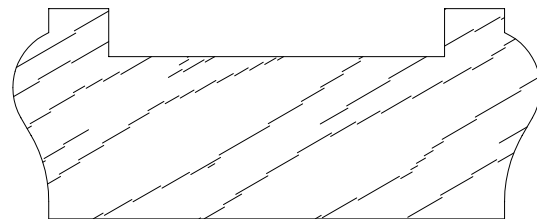

SCM 13006S
1-3/32 X 2-3/4

- HANDRAIL -

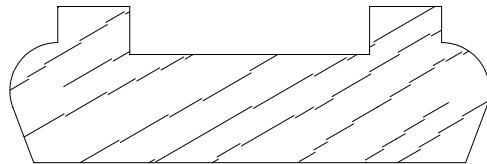

SCM 13007S
13/16 X 2-1/2

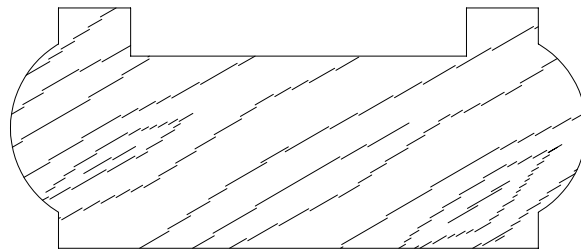

SCM 13008S
1-1/4 X 3

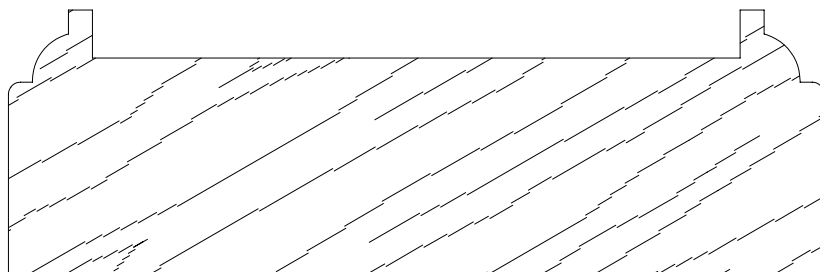

SCM 13009S
1-3/8 X 4-1/4

- HANDRAIL -

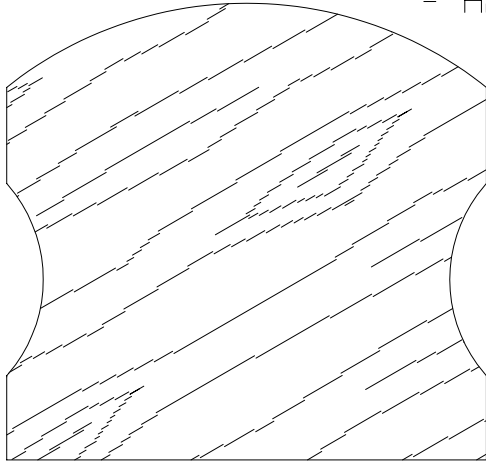

SCM 13020
2-3/8 X 2-1/2

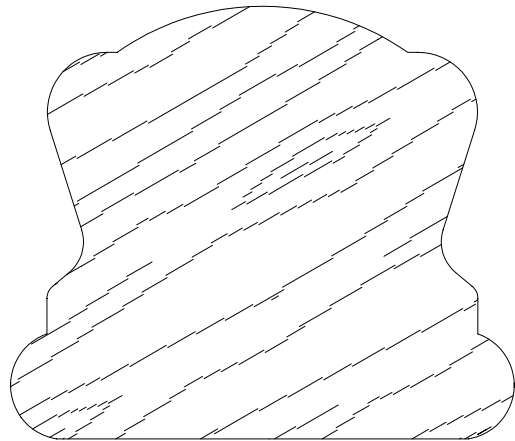

SCM 13021
2-1/4 X 2-5/8

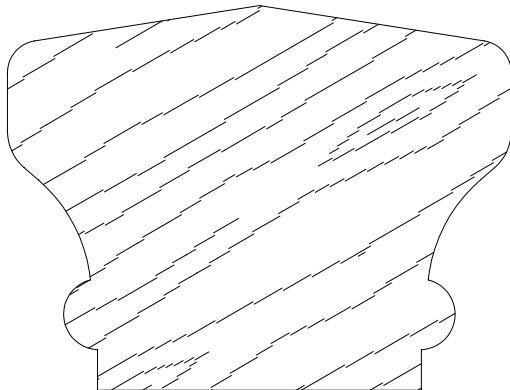

SCM 13022
2 X 2-5/8

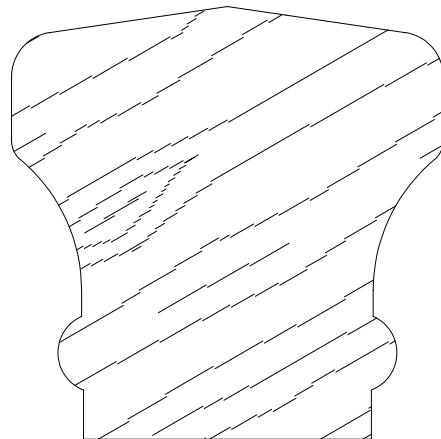

SCM 13023
2-1/4 X 2-1/4

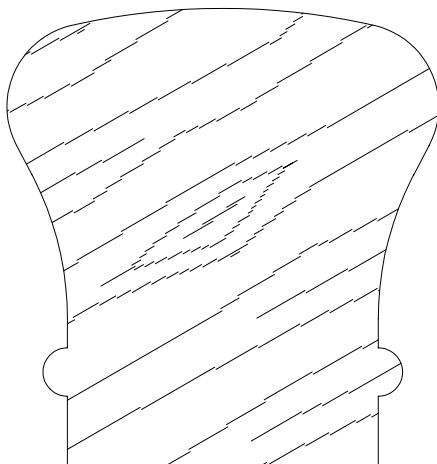

SCM 13024
2-1/4 X 2-3/8

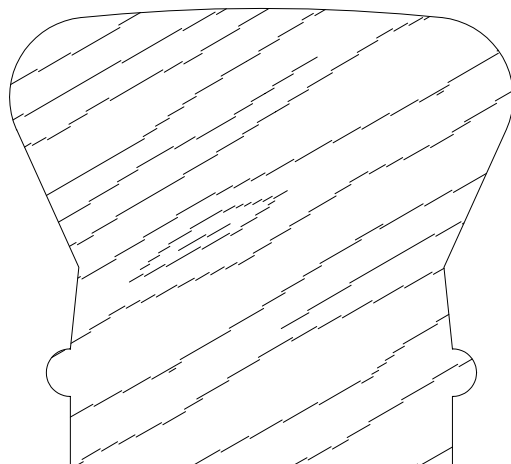

SCM 13025
2-3/8 X 2-5/8

- HANDRAIL -

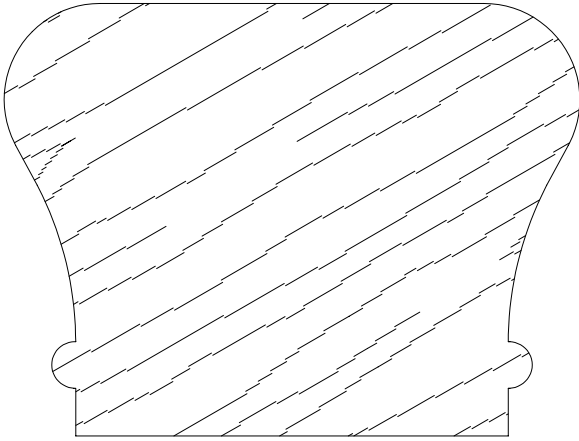

SCM 13026
2-1/4 X 3

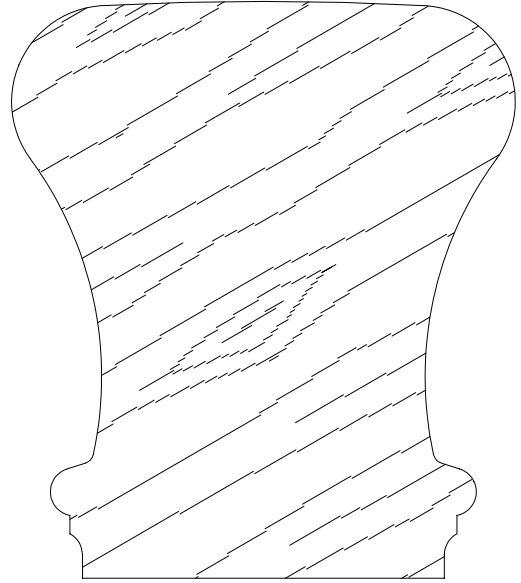

SCM 13027
2-5/8 X 3

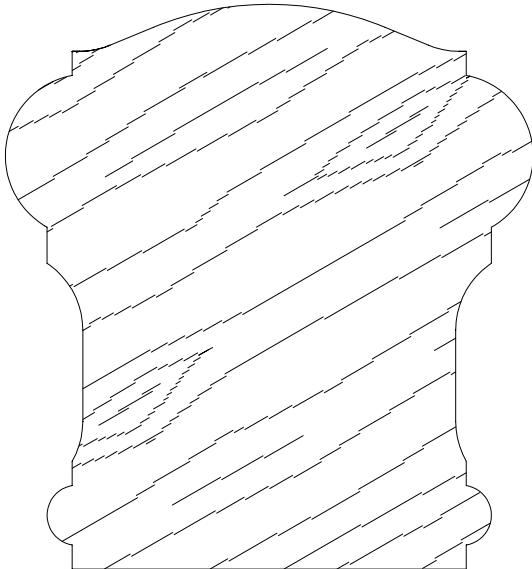

SCM 13028
2-3/4 X 2-15/16

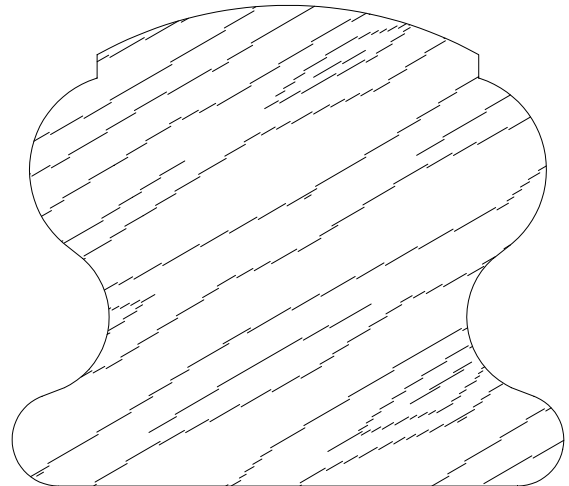

SCM 13029
2-1/2 X 2-7/8

- HANDRAIL -

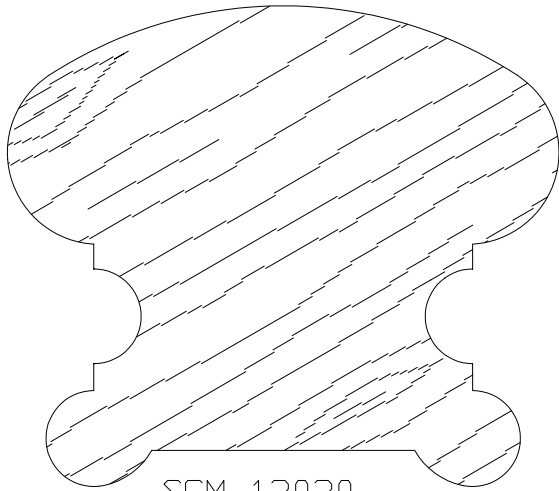

SCM 13030
2-1/2 X 2-7/8

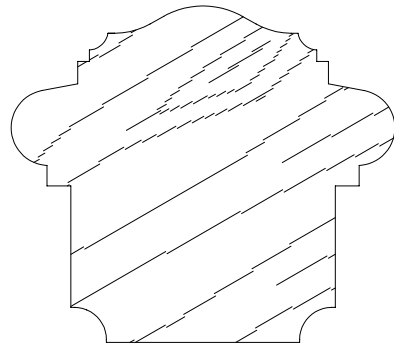

SCM 13031
1-3/4 X 2

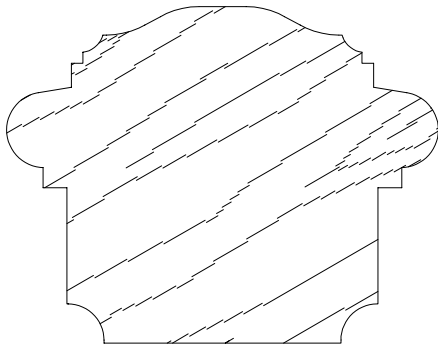

SCM 13032
1-3/4 X 2-1/4

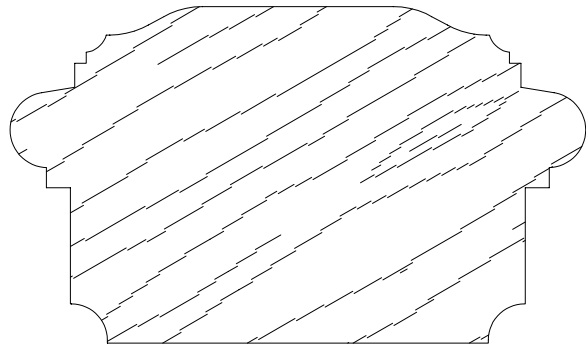

SCM 13033
1-3/4 X 3

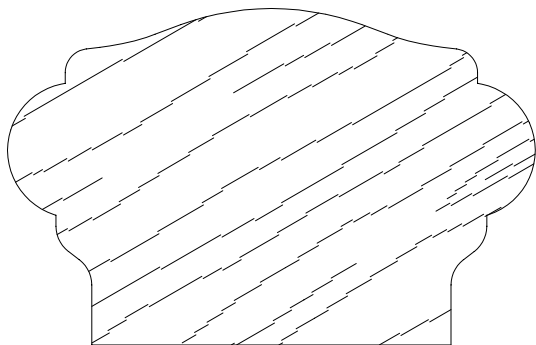

SCM 13034
1-3/4 X 2-3/4

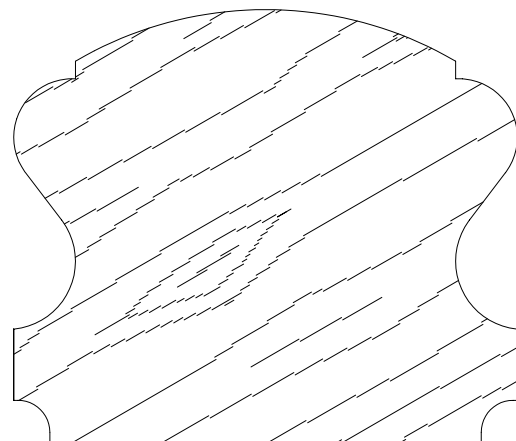

SCM 13035
2-1/4 X 2-5/8

- HANDRAIL -

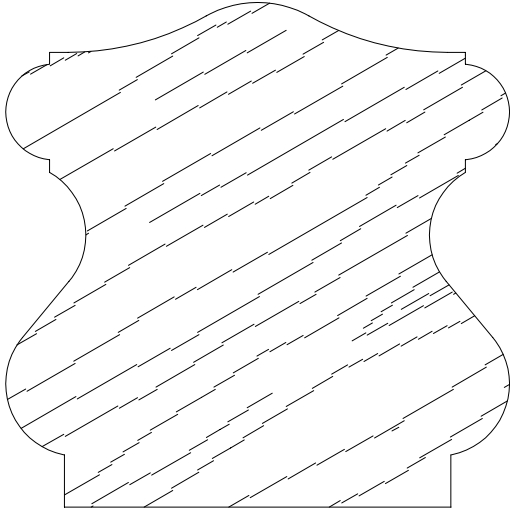

SCM 13037
2-5/8 X 2-5/8

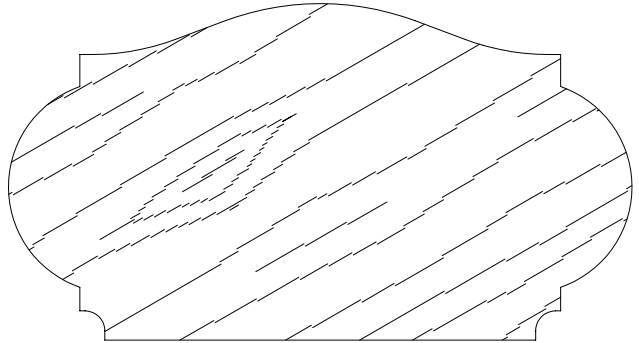

SCM 13038
1-3/4 X 3-1/4

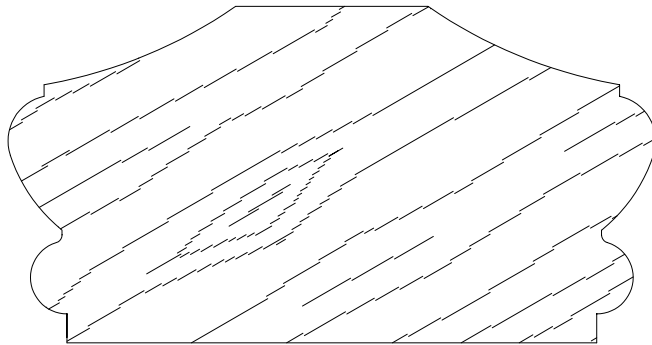

SCM 13039
1-3/4 X 3-3/8

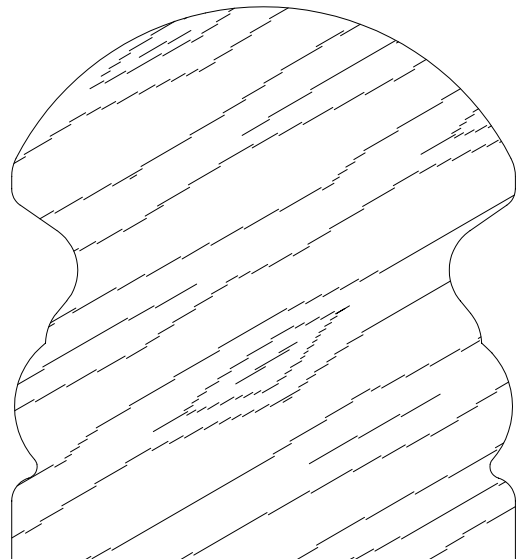

SCM 13040
2-5/8 X 2-7/8

- HANDRAIL -

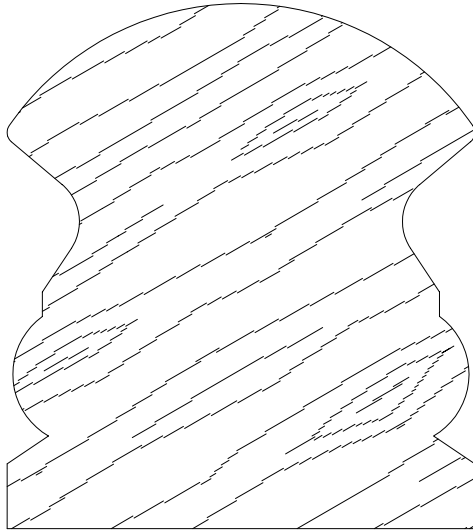

SCM 13041
2-7/16 X 2-3/4

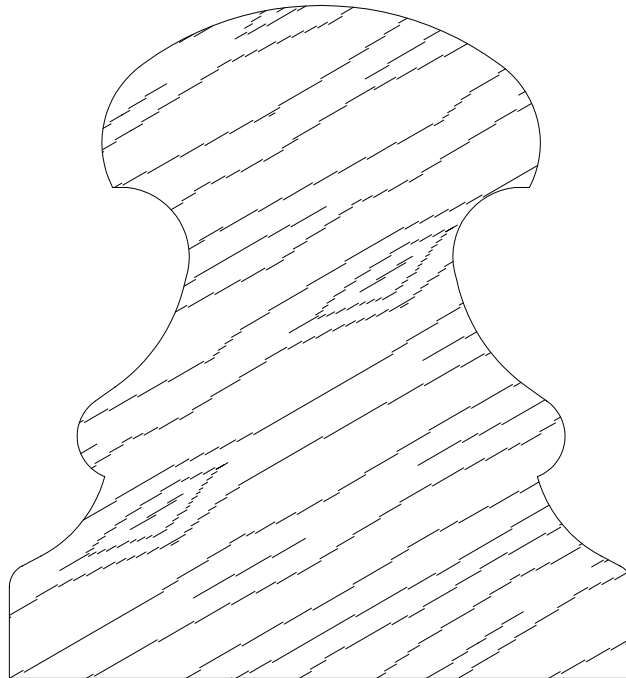

SCM 13042
3-1/4 X 3-1/2

- HANDRAIL -

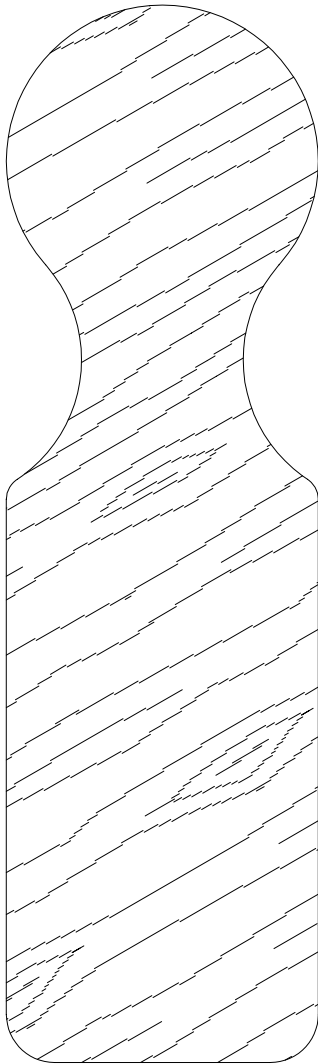

SCM 13043
1-5/8 X 5-1/2

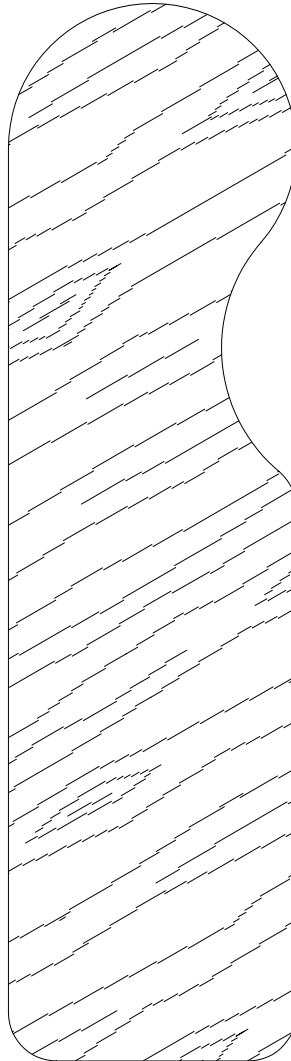

SCM 13044
1-1/2 X 5-1/2

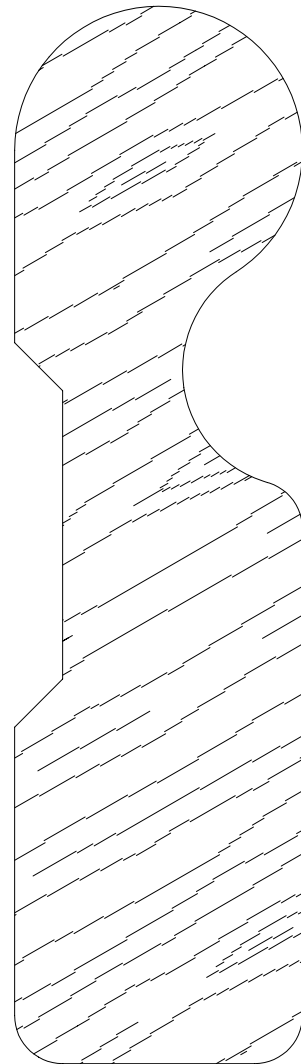

SCM 13045
1-1/2 X 5-1/2

- HANDRAIL -

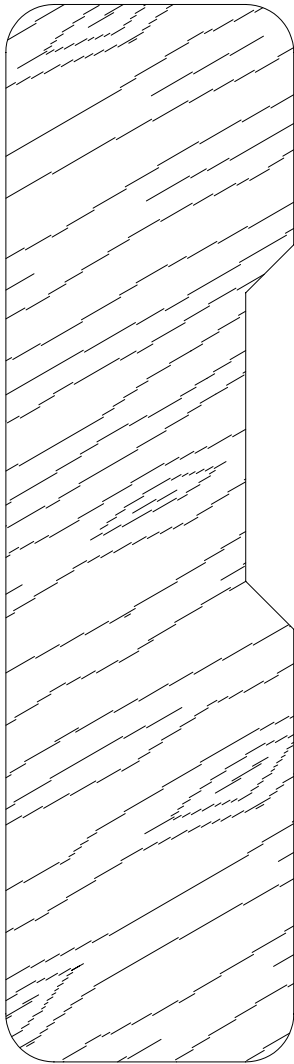

SCM 13046
1-1/2 X 5-1/2

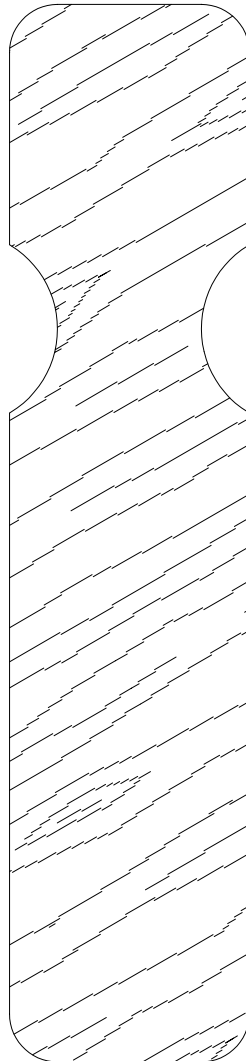

SCM 13047
1-1/4 X 5-1/2

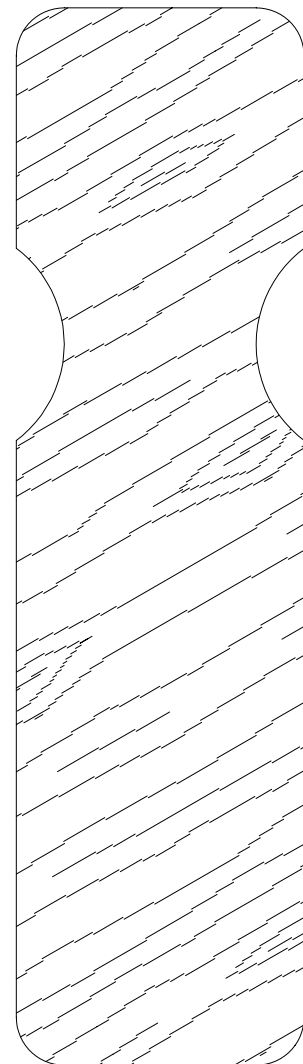

SCM 13048
1-1/2 X 5-1/2

- HANDRAIL -

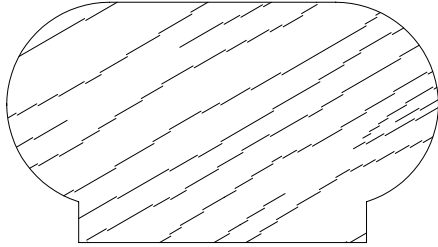

SCM 13049
1-1/4 X 2-1/4

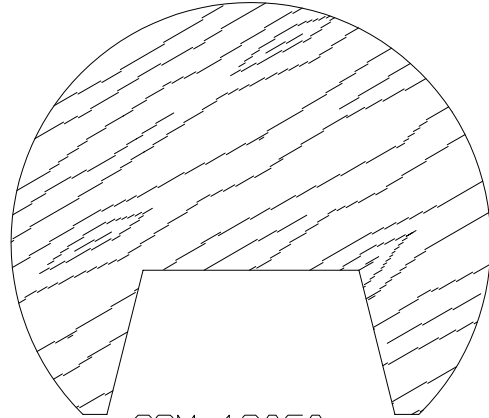

SCM 13050
2-1/8 X 2-1/2

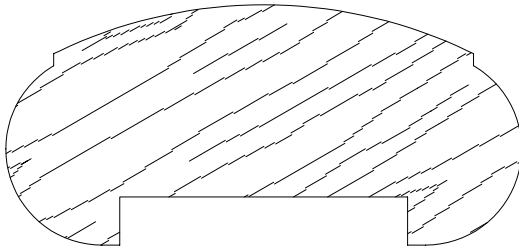

SCM 13051
1-1/4 X 2-11/16

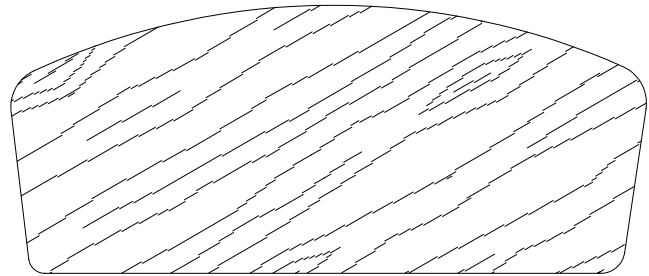

SCM 13052
1-13/32 X 3-5/16

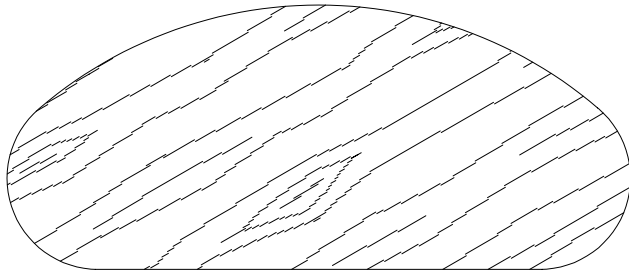

SCM 13053
1-3/8 X 3-1/4

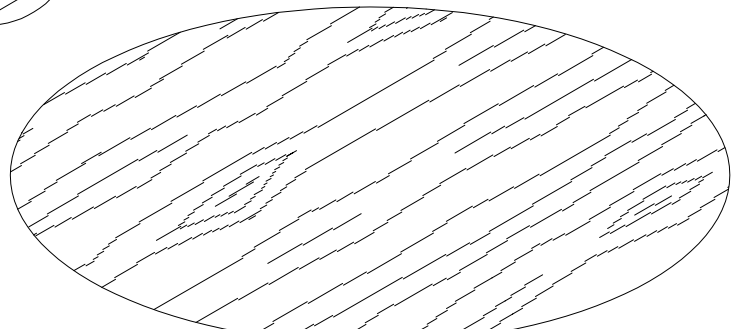

SCM 13054
1-3/4 X 3-3/8

- HANDRAIL -

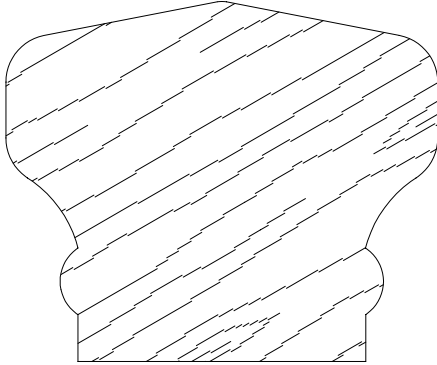

SCM 13055
1-7/8 X 2-1/4

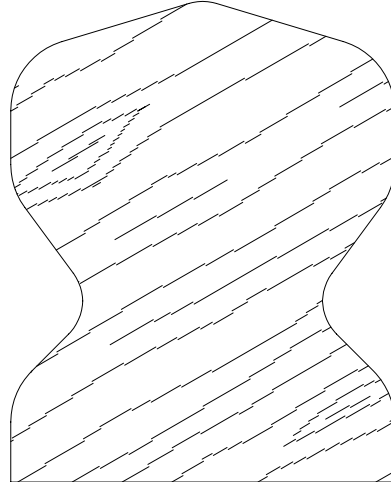

SCM 13056
2 X 2-1/2

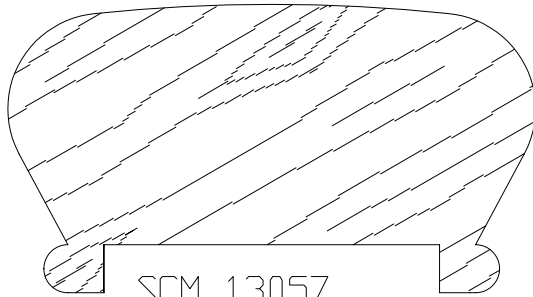

SCM 13057
1-1/2 X 2-3/4

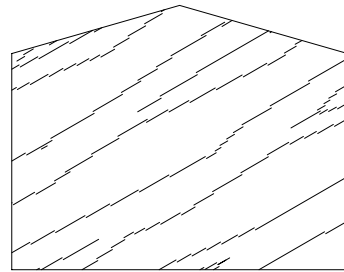

SCM 13058
1-3/8 X 1-3/4

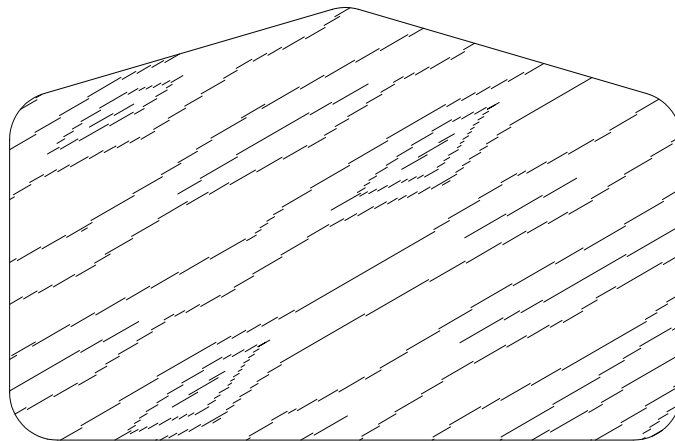

SCM 13059
2-1/4 X 3-1/2

- HANDRAIL -

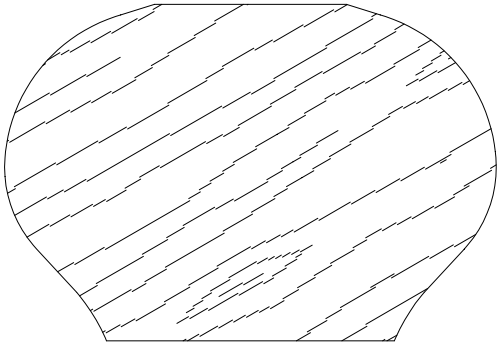

SCM 13060
1-3/4 X 2-9/16

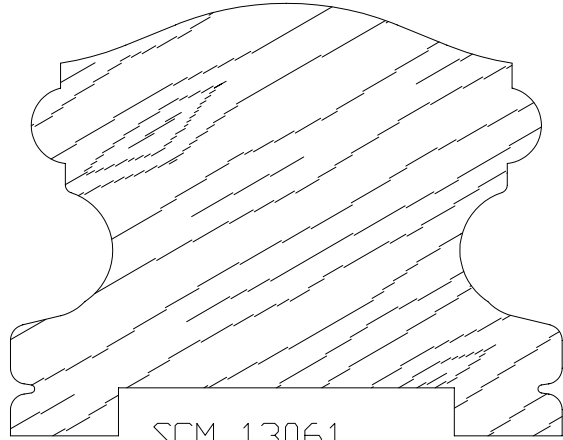

SCM 13061
2-1/4 X 2-7/8

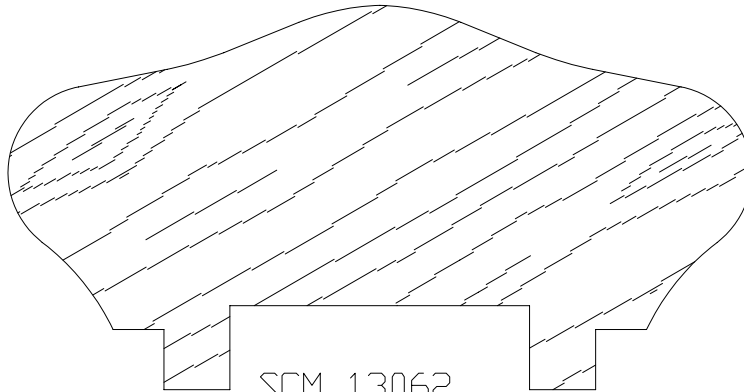

SCM 13062
2 X 3-7/8

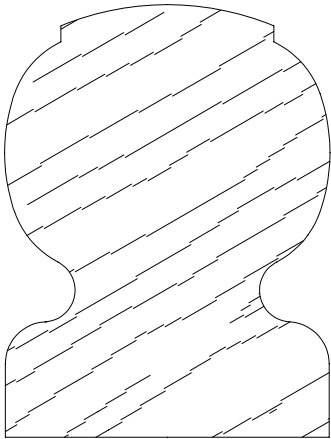

SCM 13063
1-11/16 X 2-1/4

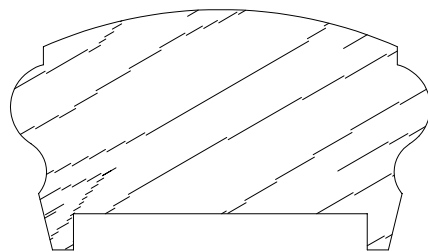

SCM 13064
1-1/4 X 2-3/16

SEATTLE CABINET & MILLWORK
16705 Tye St. SE Monroe WA 98272
Toll Free (866) 563-9129 Fax (360) 794-5331

- HANDRAIL -

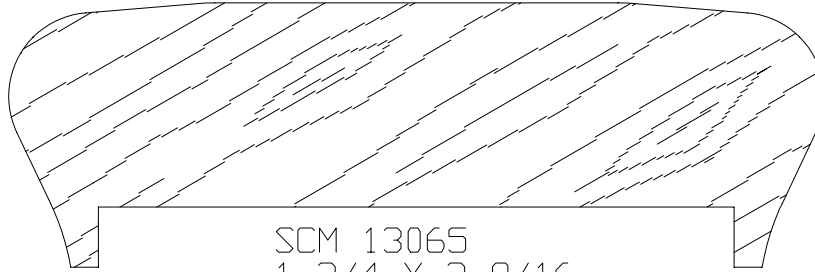

SCM 13065
1-3/4 X 2-9/16

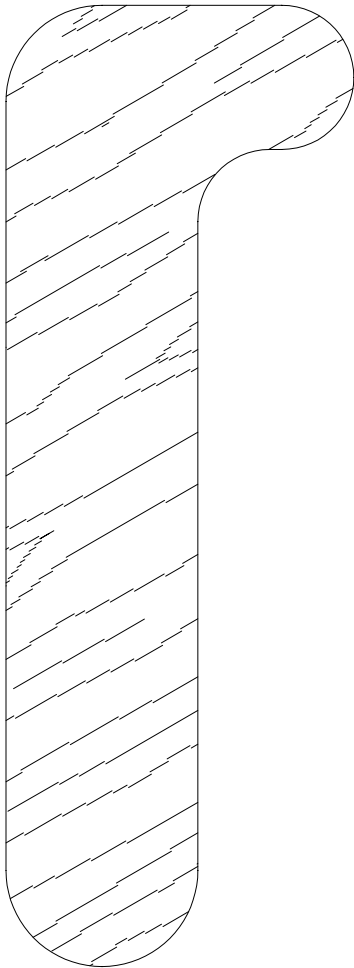

SCM 13066
1-13/16 X 5

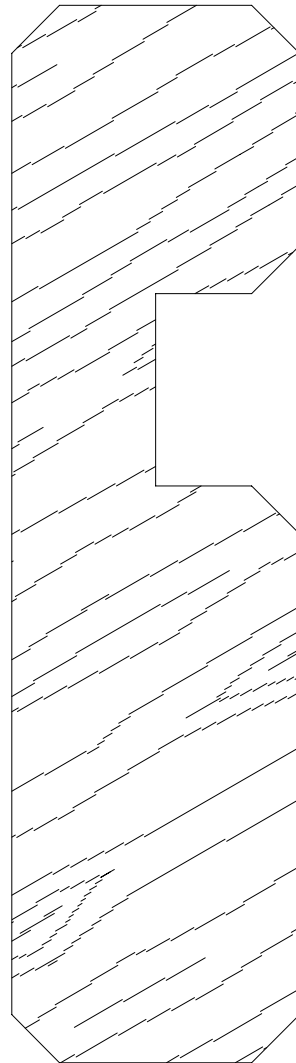

SCM 13067
1-1/2 X 5-1/2

- HANDRAIL -

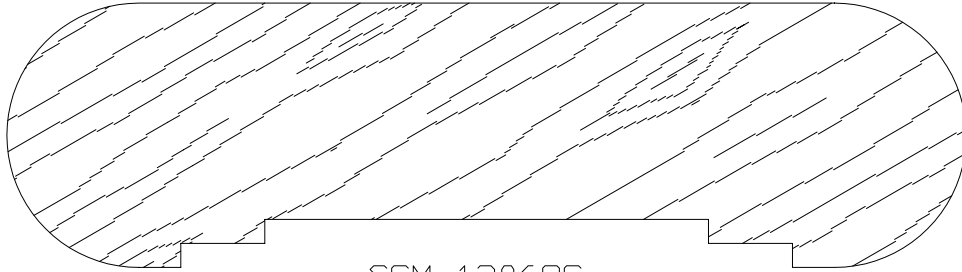

SCM 13068C
1-3/8 X 5

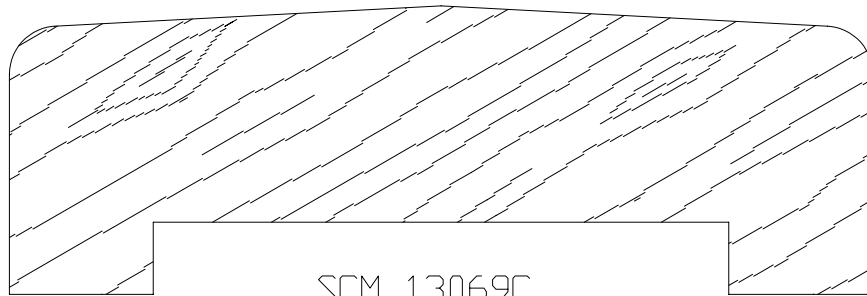

SCM 13069C
1-1/2 X 4-1/2

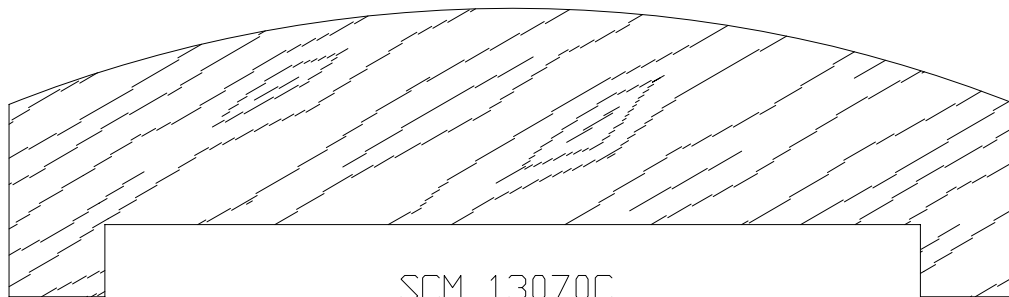

SCM 13070C
1-1/2 X 5-1/4

SEATTLE CABINET & MILLWORK
16705 Tye St. SE Monroe WA 98272
Toll Free (866) 563-9129 Fax (360) 794-5331

- HANDRAIL -

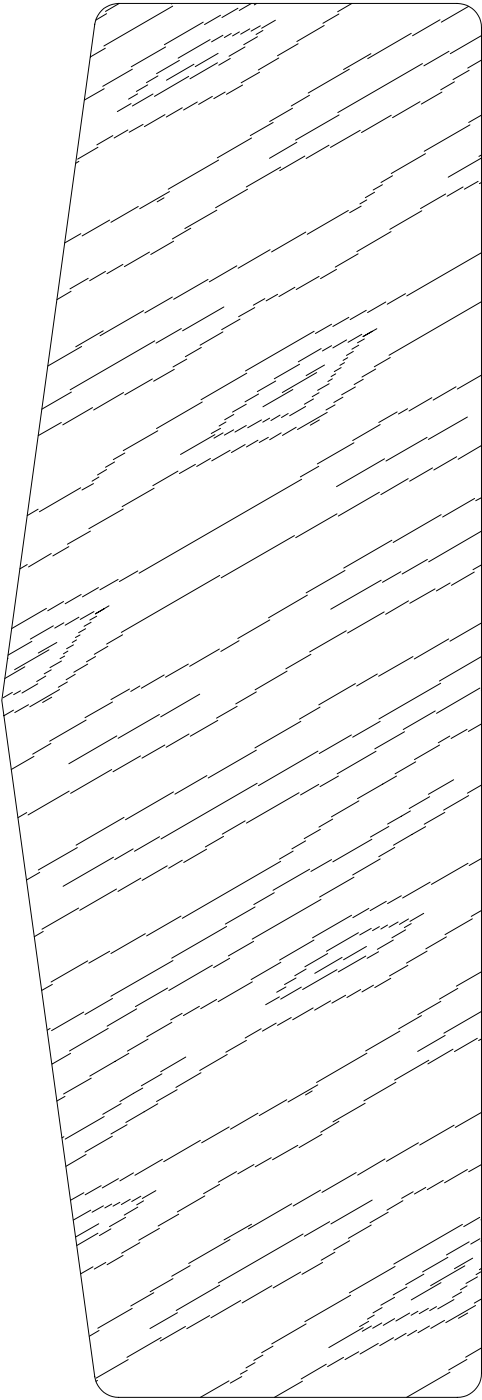

SCM 13071C
2-1/2 X 7-1/4

SEATTLE CABINET & MILLWORK
16705 Tye St. SE Monroe WA 98272
Toll Free (866) 563-9129 Fax (360) 794-5331

- HANDRAIL -

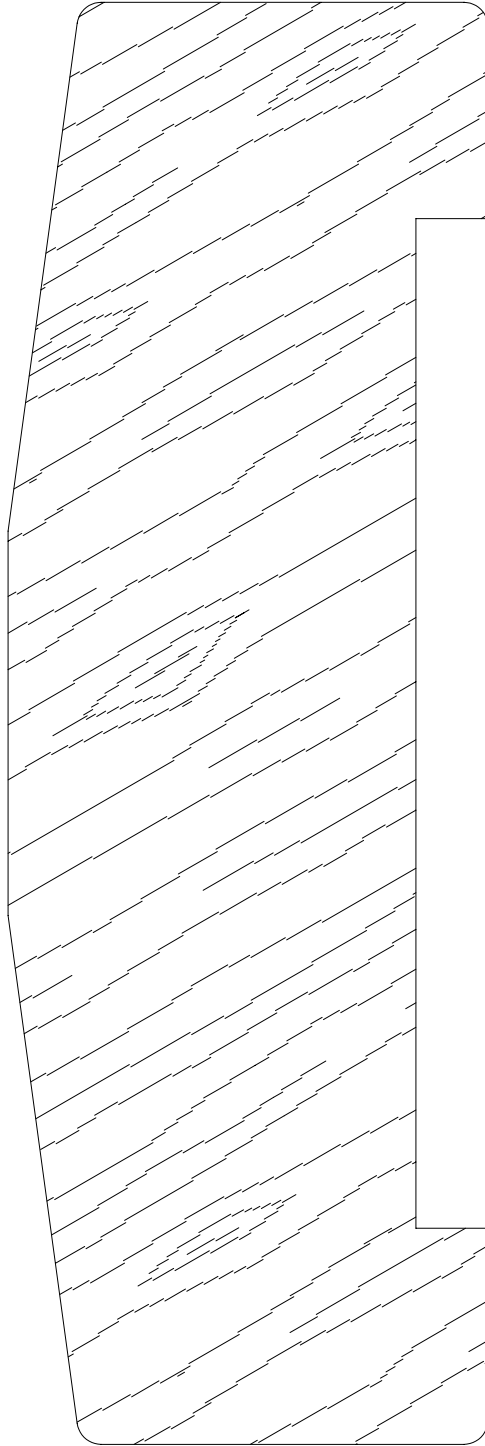

SCM 13072C
2-1/2 X 7-1/2

SEATTLE CABINET & MILLWORK
16705 Tye St. SE Monroe WA 98272
Toll Free (866) 563-9129 Fax (360) 794-5331

- HANDRAIL -

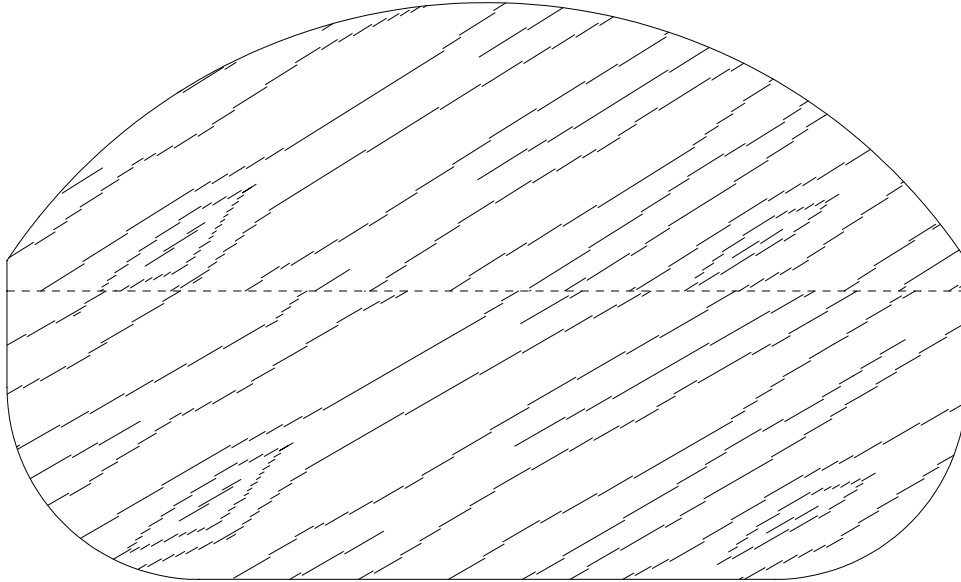

SCM 13073C
3 X 5

SEATTLE CABINET & MILLWORK
16705 Tye St. SE Monroe WA 98272
Toll Free (866) 563-9129 Fax (360) 794-5331

- HANDRAIL -

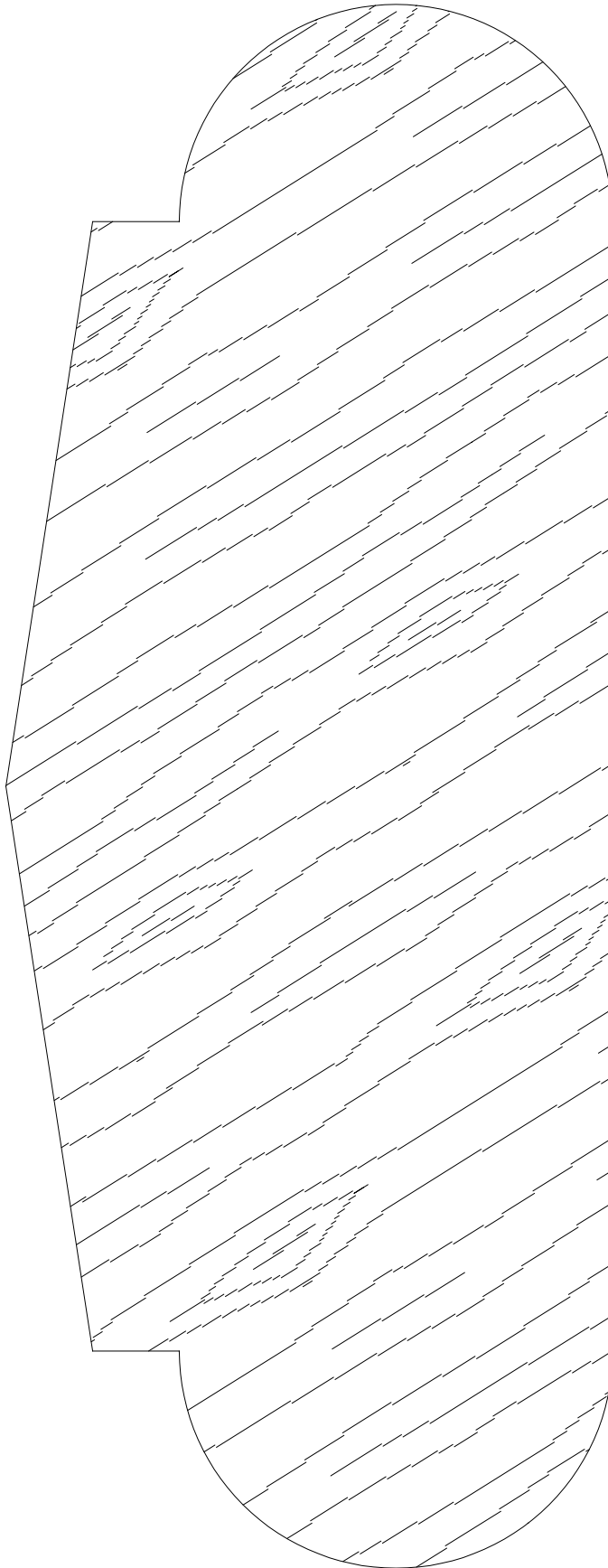

SCM 13074C
3-1/2 X 9

SEATTLE CABINET & MILLWORK
16705 Tye St. SE Monroe WA 98272
Toll Free (866) 563-9129 Fax (360) 794-5331

- HANDRAIL -

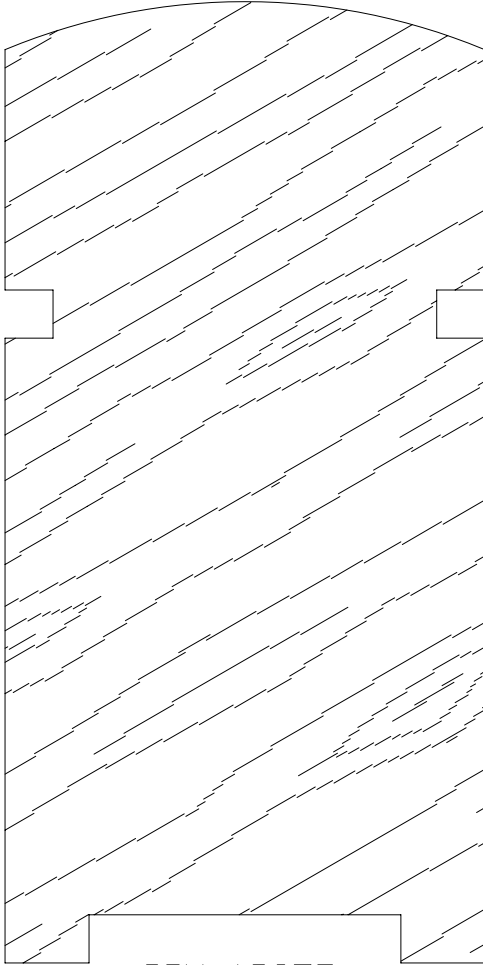

SCM 13075
2-1/2 X 5